

Sistema: 8xlado V5/V20 + 8x Concerto SUB con XILICA XP3060 V2.3

Salidas		Sub	Low	Mid-Hi
Gain		+4 dB	0 dB	-2,5 dB
Delay		0 ms	0,41 ms	0 ms
Polaridad		+	+	+
HPF	Freq	33 Hz	100 Hz	304 Hz
	Slope	24 dB/oct	24 dB/oct	18 dB/oct
	Shape	Linkwitz-Riley	Linkwitz-Riley	Butterworth
LPF	Freq	100 Hz	341 Hz	Out
	Slope	24 dB/oct	24 dB/oct	
	Shape	Linkwitz-Riley	Linkwitz-Riley	
PEQ1	Freq		354 Hz	9045 Hz
	Level		-9 dB	+4,5 dB
	Type		Peaking	Hi Shelving
	Bandwidth		0,22 Oct	1,79 Oct
PEQ2	Freq		150 Hz	4029 Hz
	Level		+4 dB	-4 dB
	Type		Peaking	Peaking
	Bandwidth		0,56 Oct	0,22 Oct
PEQ3	Freq			4029 Hz
	Level			-4,75 dB
	Type			Peaking
	Bandwidth			1,57 Oct
PEQ4	Freq			1015 Hz
	Level			+4,5 dB
	Type			Peaking
	Bandwidth			0,56 Oct
PEQ5	Freq			
	Level			
	Type			
	Bandwidth			
Limitación		Sub	Low	Mid-Hi
Threshold		1,5 dBu	-1,0 dBu	1,5 dBu
	Attack	30 ms	10 ms	3 ms
	Release	X16 (480 ms)	X16 (160 ms)	X16 (48 ms)

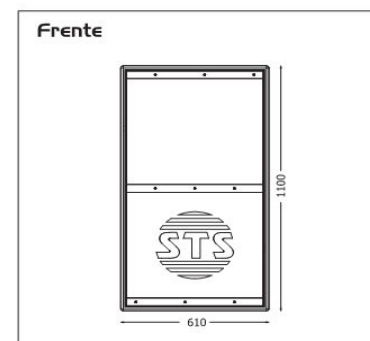
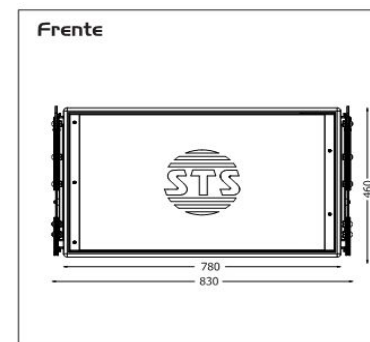

Notas
Outputs 1 y 2 SUB
Outputs 3 y 4 LOW
Outputs 5 y 6 MID-HIGH
Amplificador
Powersoft K6 / K8
Gain: 35dB

- Notas: 1. Los valores expresados en esta planilla son solo aplicables a procesadores de la marca Xilica y del modelo de amplificador Powersoft indicado
 2: Los niveles de ganancia entre vías son validos siempre que se utilicen amplificadores de la misma ganancia.
 3: Los valores de los limitadores deberán ser ajustados de acuerdo a la potencia y ganancia de los amplificadores utilizados.

Versión: 2.3